

AMBIENT TEMPERATURE REQUIREMENTS: 60-80 F
 MINIMUM CLEARANCE AROUND SYSTEM IS 36"

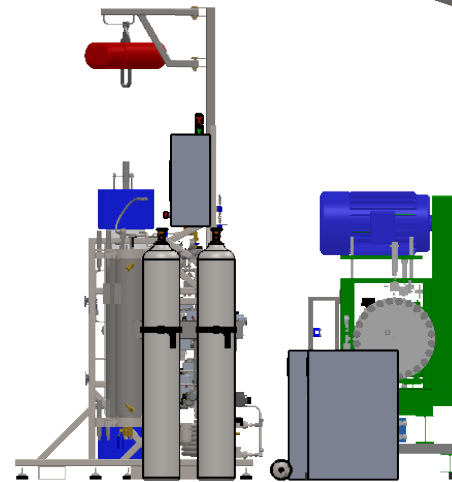
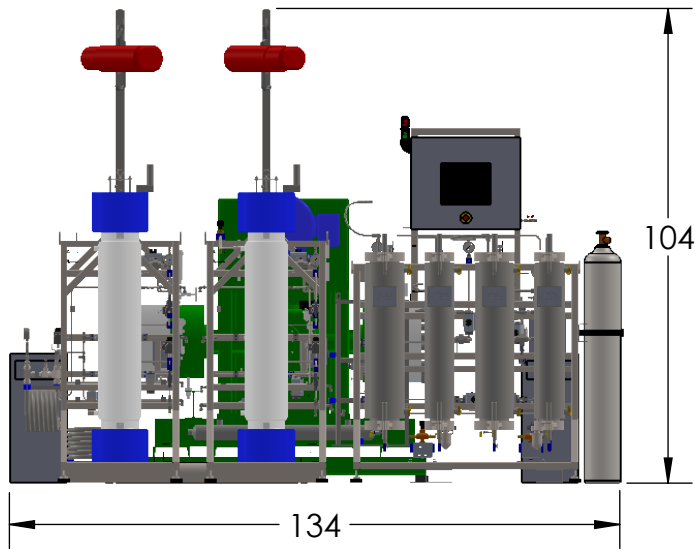
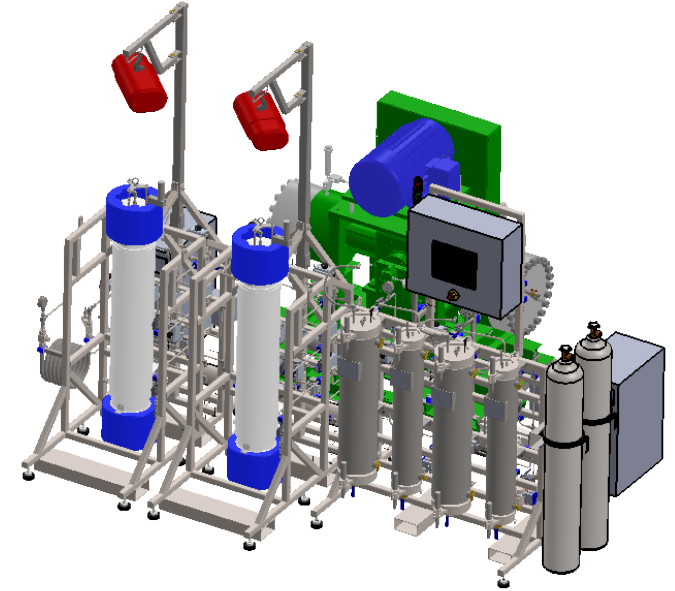
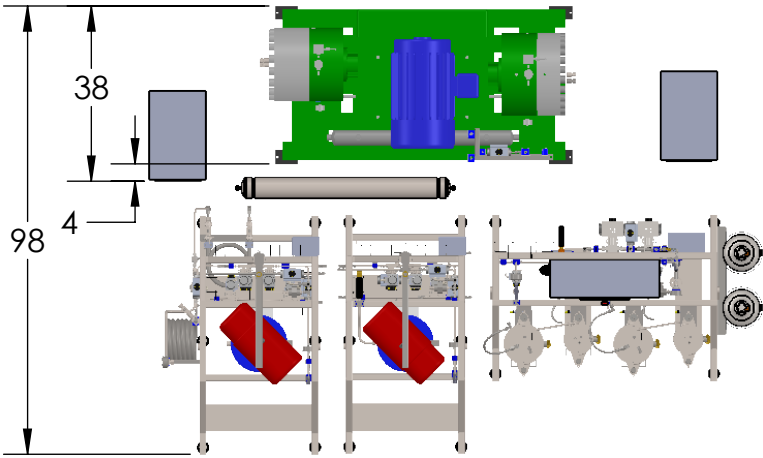

apeks®
 SUPERCritical

The Power of CO₂ Extraction™

Crate	Height	Width	Length	Weight
Extractors	76"	63"	76"	1 600 lbs
Separators	84"	50"	62"	1 350 lbs
Compressor	70"	47"	82"	5 000 lbs
TCUs	36"	48"	48"	500 lbs
Step-Up Transformer	46"	34"	32"	1 000 lbs

150 Commerce Blvd.
 Johnstown, OH 43031
 740-809-1160

MATERIAL

FINISH

RAW MATERIAL

TITLE: 8/29/2019

5000-20LX20LD 2ST
 FOOTPRINT

DWG. NO. REV.
 5000-20LX20L 2ST EXT CHR

SCALE: 1:42

SHEET 1 OF 3

EXTRACTOR B

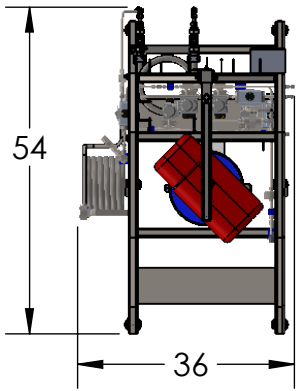

EXTRACTOR A

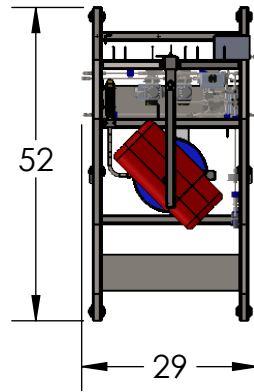

SEPARATOR

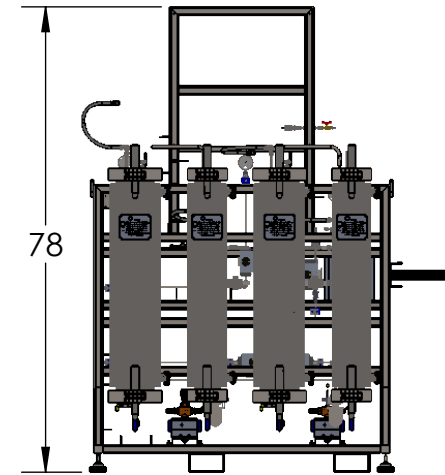
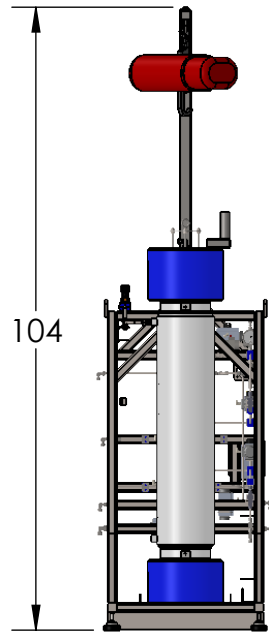
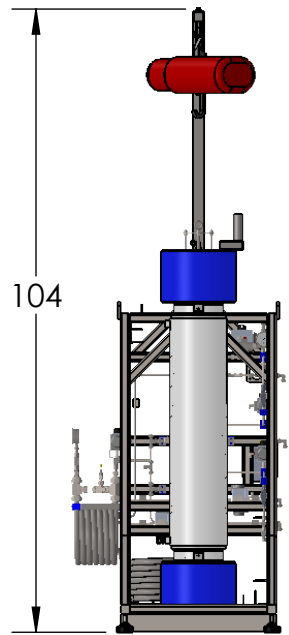
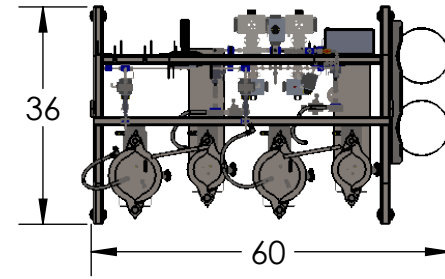

apeks®
SUPERCritical
 The Power of CO₂ Extraction™

150 Commerce Blvd. Johnstown, OH 43031 740-809-1160	TITLE: 8/29/2019 5000-20LX20LD 2ST FOOTPRINT
MATERIAL	DWG. NO. REV. 5000-20LX20L 2ST EXT CHR
FINISH	SCALE: 1:32 SHEET 2 OF 3
RAW MATERIAL	

DIAPHRAGM PUMP

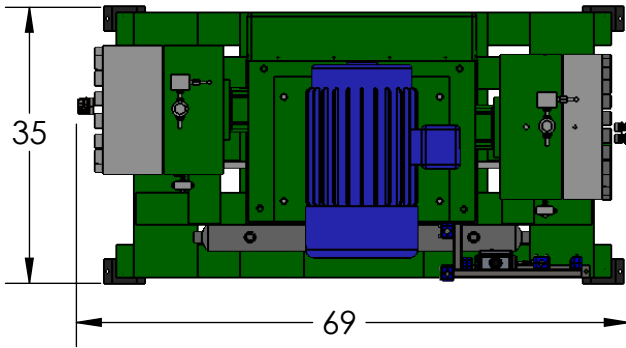

TCU

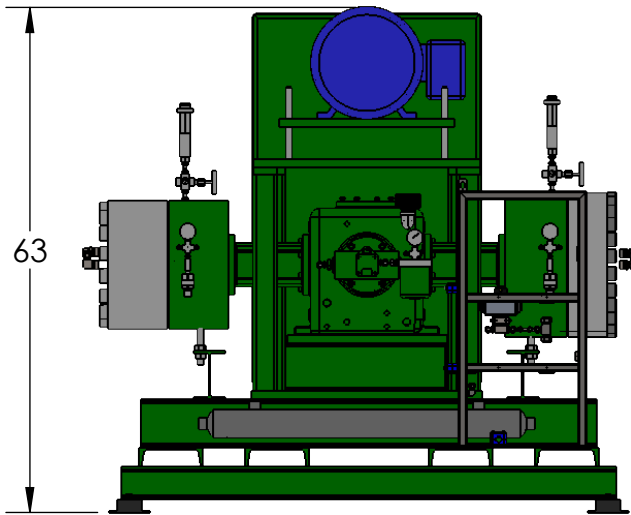
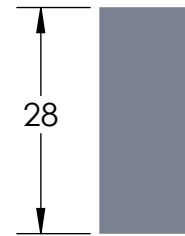
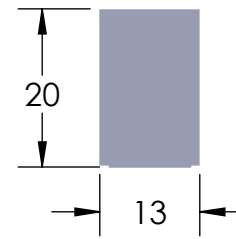

apeks®
SUPERCritical
The Power of CO₂ Extraction™

150 Commerce Blvd. Johnstown, OH 43031 740-809-1160	TITLE: 8/29/2019	
	5000-20LX20LD 2ST FOOTPRINT	
	MATERIAL	DWG. NO. REV.
FINISH	5000-20LX20L 2ST EXT CHR	
RAW MATERIAL	SCALE: 1:24	SHEET 3 OF 3