

AMBIENT TEMPERATURE
REQUIREMENTS: 60-80 F

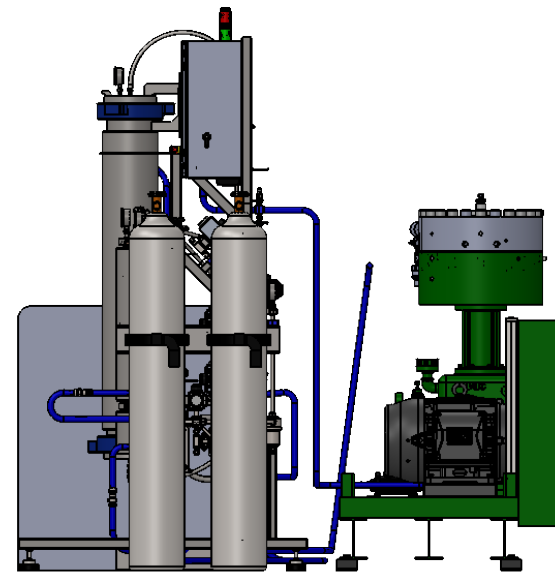
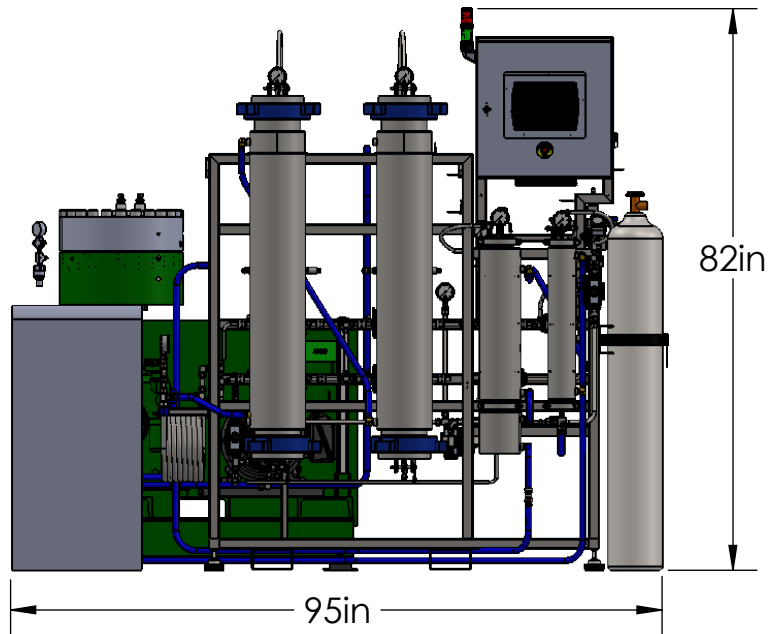
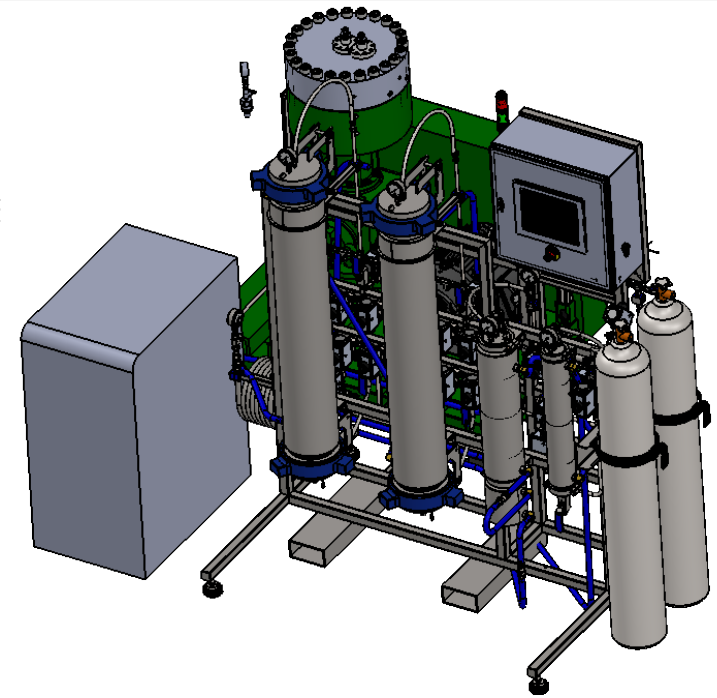

apeks®
SUPERCRITICAL
The Power of CO₂ Extraction™

EQUIPMENT	CRATE SIZE	CRATE WT.
2000-20LX20LD	65" X 40" X 82"	1150 LBS
DIA. PUMP	57" X 39" X 67"	2750 LBS
CHILLER	48" X 26" X 36"	390 LBS

NOTE: MINIMUM CLEARANCE AROUND SYSTEM IS 36"

150 Commerce Blvd.
Johnstown, OH 43031
740-809-1160

MATERIAL

FINISH

RAW MATERIAL

TITLE: 6/1/2018

2000-20LX20LD SYSTEM
FOOTPRINT

DWG. NO. REV.

2000-20LX20LD

SCALE: 1:28

SHEET 1 OF 2

DIAPHRAGM PUMP

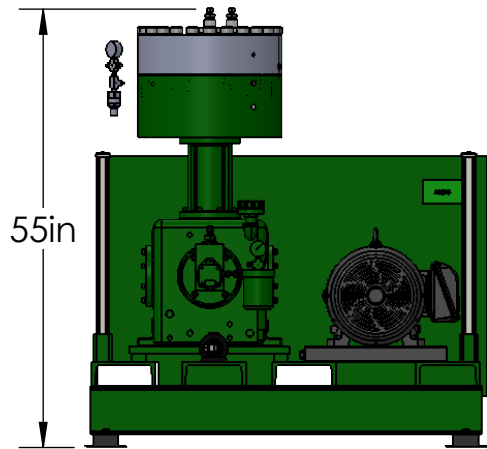
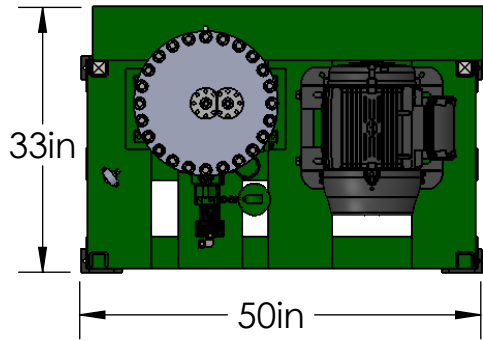

CHILLER

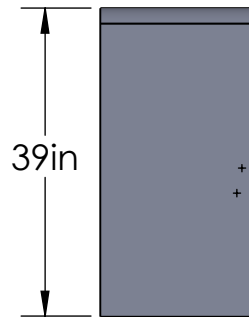
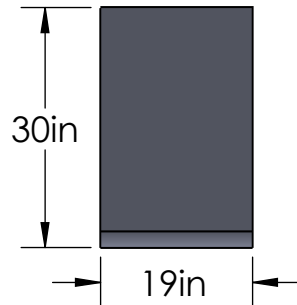

EXTRACTOR

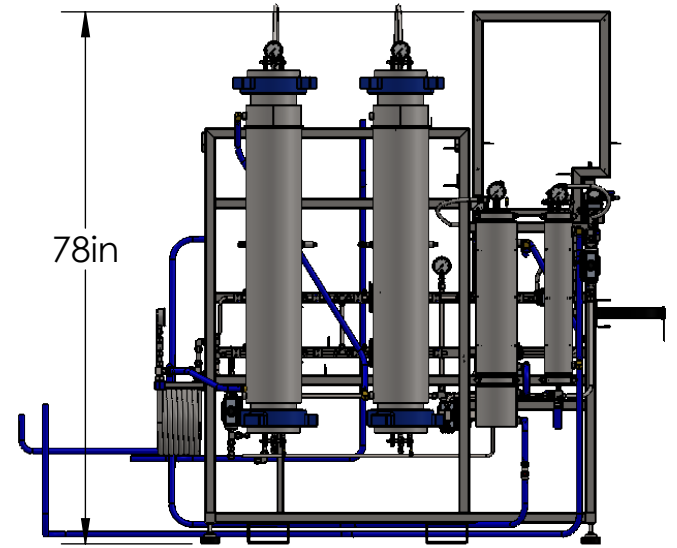
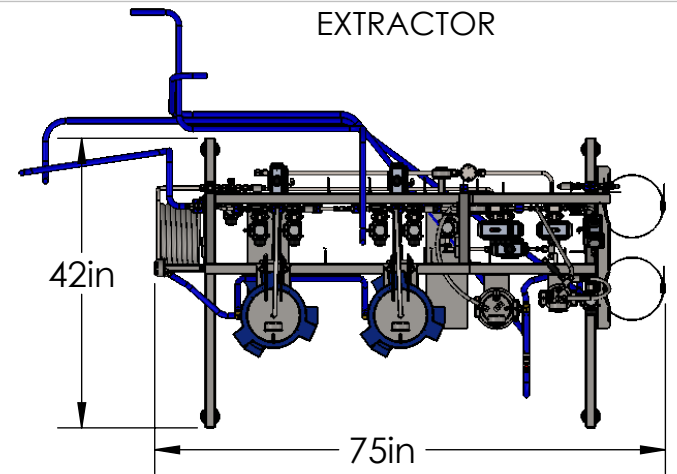

The Power of CO₂ Extraction™

150 Commerce Blvd. Johnstown, OH 43031 740-809-1160	TITLE: 6/1/2018 2000-20LX20LD SYSTEM FOOTPRINT
MATERIAL	DWG. NO. REV.
FINISH	2000-20LX20LD
RAW MATERIAL	SCALE: 1:24 SHEET 2 OF 2